

SSP-350-X-LB SPECIFICATIONS

DIRECT CONNECT FLUSH OR SURFACE MOUNTED HANDSET TELEPHONES

Vandal resistant stainless steel prison visitation or direct connect flush mount panel telephone. Units are designed to talk one to one with another unit. Equipped with a 32" armored cord handset with internal steel lanyard that is anchored into a bracket on panel, operational magnetic switch hook, tamper resistant security screws, and CEECO 4" mounting electrical box. Talk battery or power system required for operation and are sold separately.

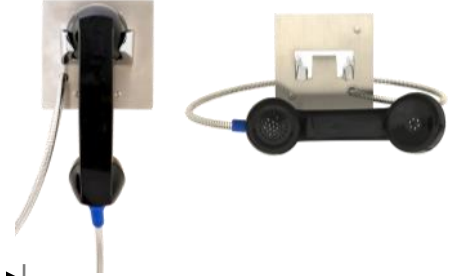





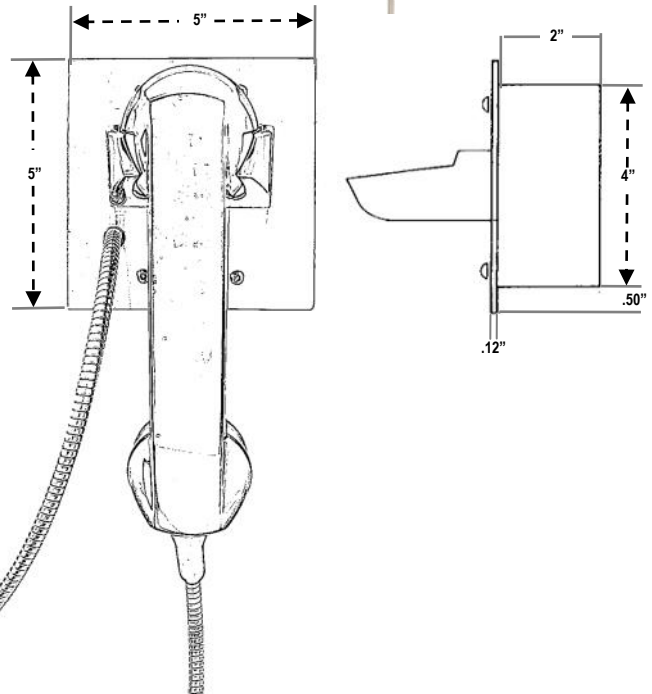

SPECIFICATIONS

Panel Size:	5" W x 5" H 3.12" D (Front Panel & Handset on Hook)
Weight:	Approximately 3 lbs.
Mounting :	Flush mount- (Standard) 4" mounting electric Box Dimensions: 4" x 4" x 2.12"D Double gang wall mount (-W) Dimensions: 4.56"x 4.62" x 2"D
Environment:	Temperature: -30°C (-22°F) to 60°C (140°F) Humidity: 0%-90% non-condensating
Input Power:	Telephone Line Powered
Loop Current:	23mA min to 80mA max
Impedance:	600 ohms
Type Jack:	RJ11C
Ringer Equivalency:	0.4A
Hearing Aid Compatible:	Meets EIA standards
UL& FCC Registration:	Certified
ACCESSORIES:	301-064 Security Tool (required for installation)









ADDITIONAL OPTIONS

IP - Voice over Internet Protocol Version available on all models (SIP)

-M	-LB	-PBVC	-RIL	-W	4" Standard Box
					
Sealed Magnetic Hookswitch • Completely Sealed • No Moving Parts	32" handset with internal steel lanyard (braided metal rope) anchored into bracket installed on panel for added strength	Push button volume control handset	Ring indicator light that is mounted on top of the phone	2-gang style grey metal surface wall mounted box Dimensions: 4.56"x 4.62" x 2"D	4" Steel Square mounting electrical box Dimensions: 4" x 4" x 2.12"D

ACCESSORIES and POWER SOURCES

350-250	350-253	350-255	350-220	350-300	350-300R
					
Power supply interface for the SSP-350-X (one per pair)	3-Way Power supply interface for the SSP-350-X (3 units per interface)	Power supply for the SSP-350-X (power for up to 6 pairs or 12 units) Input 100-240 VAC, 2A, 50/60 HZ. Output +15 VDC, 4A Dimensions: 6.25" L x 3 7/8" W x 1 3/4" D Surface Mount	Manual ring-down circuit with power supply for one set of two phones to direct connect to each other.	Visitation Control System complete with 350-250 15VDC 4A power supply; Insulated screw terminals for 32 units (16 pair); Audio balancing components all mounted on 19" by 10.5" mounting board for rack or wall mount. Mounting hardware included; completely pre-wired. Requires AC power	Visitation Control System complete with 350-250 15VDC 4A power supply; Insulated screw terminals for adding Recording capability to all pairs of devices added to system; Audio balancing components all mounted for rack or wall mounted. Mounting hardware included and completely pre-wired. Requires AC power