

WPP-530-X SPECIFICATIONS

LOW POWER HANDSFREE SPEAKERPHONE WITH AUTODIAL PUSH-BUTTON FOR RING-DOWN OPERATION IN A WEATHERPROOF HOUSING

Standard Analog Power, but also available in VoIP versions







Heavy duty stainless steel handsfree speakerphone in a cast aluminum black waterproof housing with TELEPHONE on door and pin latch for wall or pole mount. Designed with push button for ring-down operation and red LED light to indicate phone is activated. Press button to disconnect call. Telephone can be programmed to cancel calls after 1, 3, or 5 minutes or no call time-out. Phone relies on external equipment to control calling. Equipped with a weatherproof, puncture resistant speaker and microphone and tamper resistant security screws. WPP models available in black, (-R) red, (-Y) Yellow, or (-G) Gray with TELEPHONE or EMERGENCY on door.

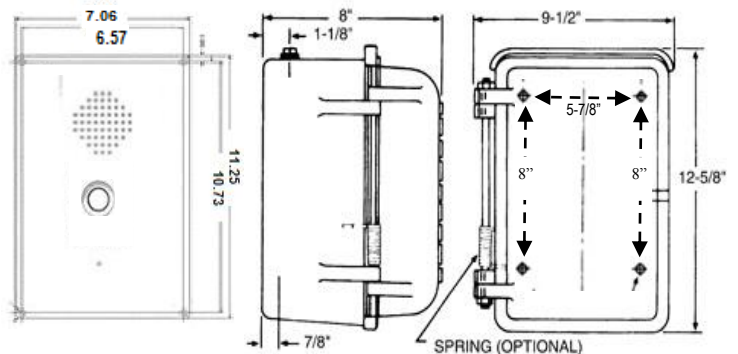

SPECIFICATIONS

Panel Size:	7 1/6"W x 11 1/4"H
Weatherproof Housing:	9 1/2"W x 12 5/8"H x 8"D (Including Door)
Weight:	Approximately 17 lbs.
Mounting Instructions:	Weatherproof Housing 4 holes spaced 8" x 5 7/8" Also available pole mounting bracket
Environment:	Temperature: -30°C (-22°F) to 60°C (140°F) Humidity: 0%-90% non-condensating
Programming:	Via Mini Jumper
Input Power:	Telephone Line Powered
Loop Current:	27mA min to 80mA max
Impedance:	600 ohms
Type Jack:	RJ11C
Ringer Equivalency:	0.4A
UL & FCC Registration:	Certified
ACCESSORIES:	301-064 Security Tool (required for installation)



ADDITIONAL OPTIONS		IP - Voice over Internet Protocol Version available on all models (SIP)					Additional Options & Features
-ADA	Weatherproof Housing	-ST/-SB/-RST	-RIL	-SP	Pole Mount		
						Auto Answer (AA) Remote Programming (RP) Voice Announcement (VA)	
<ul style="list-style-type: none"> Red/ green LED call progress indicator light Braille Emergency Plate "EMERG. PHONE" Red push button 	Standard Black & TELEPHONE on Door -B-EMER Black & EMERGENCY on Door -R Red & EMERGENCY on Door -R-TEL Red & TELEPHONE on Door -Y Yellow & EMERGENCY on Door -Y-TEL Yellow & Telephone on Door -G Grey & TELEPHONE on Door -G-EMER Grey & EMERGENCY on Door	Blue Strobe Light option: <ul style="list-style-type: none"> Steady on Flashing For location visibility Requires AC power 	Ring Indicator Light located on the phone panel for visual ring indication.	Spring loaded door option	Pole Mounting bracket fits poles 2.5" - 6".		



Providing Telecommunication Solutions Since 1930

Communication Equipment
& Engineering Company

<http://www.ceeco.net>

Email: sales@ceeco.net

519 SW Park Street

Okeechobee, FL

Voice 863-357-0798

Fax 863-357-0006