

SSC-303-F SPECIFICATIONS

LARGE WALL HANDSET TELEPHONE WITH KEYPAD AND SMART FEATURES

Standard Analog Power, but also available in VoIP versions

Vandal resistant stainless steel wall mount telephone with keypad for dialing with call restrictions. Programmable PBX, prefix, or access dialing capability, call time duration setting from no limit up to 30 minutes, allow or block incoming calls, and 40 (1-11digits) programmable speed dialing locations. Equipped with marine quality chrome tone dial keypad and mechanical hookswitch, instruction or advertising window, ID window, 32" hearing aid compatible armored cord handset with internal steel lanyard, which is anchored into the housing for added strength, tamper resistant security screws, and backplate for easy wall mounting or installation with existing type "1" coin and payphone enclosures.







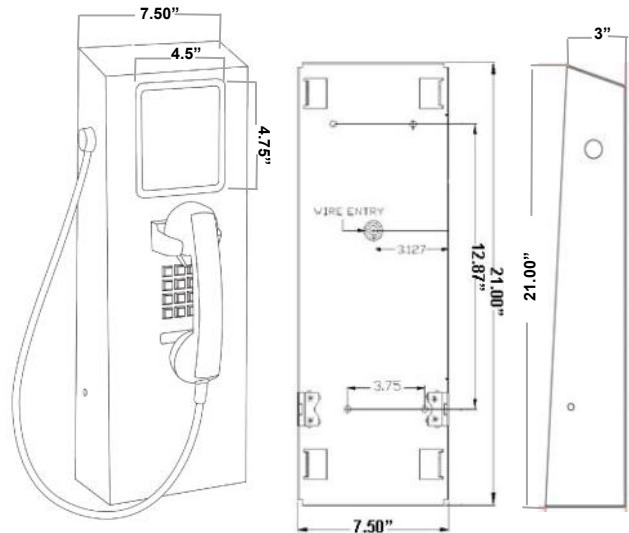

SPECIFICATIONS

Panel Size:	7.5" W x 21" H x 4.10" D 6.5" D With handset on Hook
Weight:	Approximately 16 lbs.
Mounting Instructions:	Vertical Surface Mount: Separate the cover assembly from the backplate. The backplate assembly is designed to be mounted on any flat vertical surface. Four mounting holes are provided.
Environment:	Temperature: -30°C (-22°F) to 60°C (140°F) Humidity: 0%-90% non-condensing
Programming:	Via DTMF Keypad
Memory Retention:	Lithium Battery— Long Life
Input Power:	Telephone Line Powered
Loop Current:	25mA min to 80mA max
Impedance:	600 ohms
Type Jack:	RJ11C
Ringer Equivalency:	0.4A
Hearing Aid Compatible:	Meets EIA standards
UL & FCC Registration:	Certified
ACCESSORIES:	301-037 Security Tool (required for installation)



ADDITIONAL OPTIONS

IP - Voice over Internet Protocol Version available on all models (SIP)

-M	-IVC	-ACH**	-ACH*	-CCH*	-RIL	-RIS
						
Sealed Magnetic Hookswitch • Completely Sealed • No Moving Parts	Push Button Volume Control • Background Noise reducer	Other Length armored cord from 12" to 72"(inches). Example: -ACH12 12" Long	ACHW-White Handset ACHR-Red Handset (Black is standard)	Coiled cord available from 5', 10', & 15' (feet). Example: -CCH5 5' Long	Ring Indicator Light located on the phone panel for visual ring indication	Ring Indicator Flashing Blue Light (Requires AC Power)



Providing Telecommunication Solutions Since 1930

Communication Equipment
& Engineering Company

http://www.ceeco.net
Email: sales@ceeco.net

519 SW Park Street
Okeechobee, FL

Voice 863-357-0798
Fax 863-357-0006