

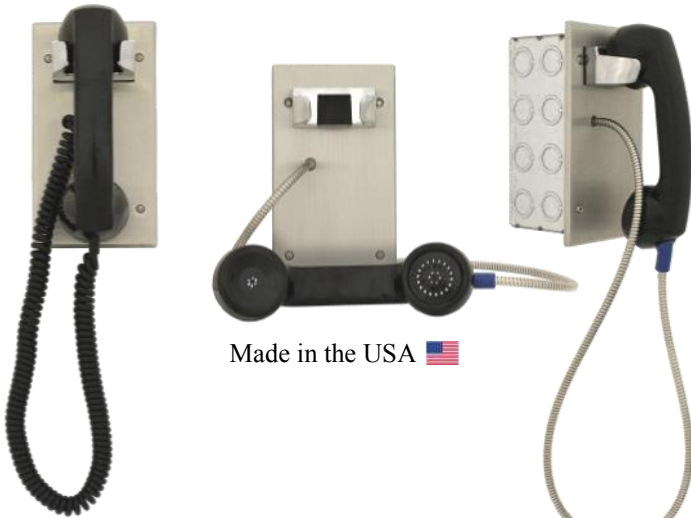

MINI PANEL HANDSET PHONES

351 STAINLESS STEEL MINI PANEL WITH MASONRY MOUNTING BOX

The CEECO Models SSP-351-D-M and SSP-351-X-M are sturdy, vandal resistant, stainless steel telephones designed to provide a compact flush mount automatic dialing or ring-down panel telephone for areas subject to abuse, high use, and vandalism. Ideally, these units are suited for hotline, ATM service, emergency service, or courtesy telephone communication.



Made in the USA 

SPECIFICATIONS

Panel Size:	4.50" W x 8.25" H 3.50" D (Behind Panel) 3" D (Front Panel & Handset on Hook)
Weight:	Approximately 6 lbs.
Mounting:	Flush Mounted 4-gang metal masonry box flush mounting box Dimensions: 3.75"W x 7.40"H x 3.50" D
Programming:	Via Mini Jumpers
Environment:	Temperature: -30°C (-22°F) to 60°C (140°F) Humidity: 0%-90% non-condensating
Input Power:	Telephone Line Powered
Loop Current:	23mA min to 80mA max
Impedance:	600 ohms
Type Jack:	RJ11C
Ringer Equivalency:	0.4A
Hearing Aid Compatible:	Meets EIA standards
UL& FCC Registration:	Certified

FEATURES

Standard 4 gang electrical Masonry Mounting Box Included

Stainless Steel Construction with Tamper Resistant Hardware

32" Armored Cord Handset

Magnetic Hookswitch with no Moveable Parts

Flush Mount Installation

Available in Ring-down or Autodial

Incoming Calls Accepted or No Ringer to Avoid Incoming Calls

Line Powered

1 Year Warranty

Requires 301-064 Security Tools for Installation

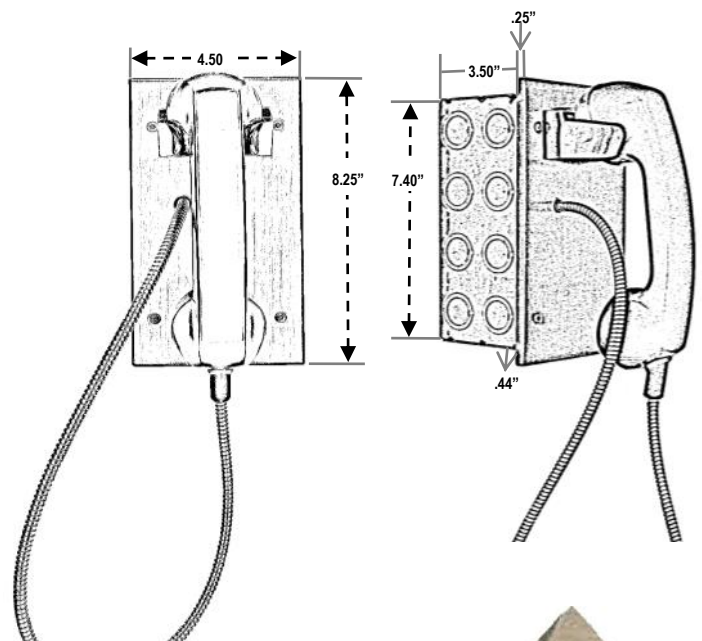



CEECO has been providing telecom solutions since 1930. Our vandal resistant technology focuses on providing public communication solutions while reducing replacement and repair costs, lowering the customer's total cost of ownership. CEECO also offers custom design and branding to your specifications. Our commitment to providing expert service and support extends beyond the warranty of our product. We offer support for the life of the product! CEECO is devoted to giving you the quality and service you deserve.





PROVIDING EXCELLENT PRODUCT & SERVICE YOU CAN TRUST, SINCE 1930

MINI PANEL HANDSET PHONES

351 STAINLESS STEEL MINI PANEL TELEPHONES

Stainless Steel Mini Panel Handset Phones with Masonry Mounting Box

MINI PANEL AUTO DIAL PHONE	MINI PANEL RINGDOWN PHONE	MINI PANEL AUTO DIAL WITH VoIP
 <p>SSP-351-D-M</p>	 <p>SSP-351-X-M</p>	 <p>IP-SSP-351-X-M-CHS</p>
<p>Dimensions: 4.55" W x 8.25" H x 3.10" D</p>	<p>Dimensions: 4.55" W x 8.25" H x 3.10" D</p>	<p>Dimensions: 4.55" W x 8.25" H x 3.10" D</p>
<p>Mini Stainless Steel Panel with Masonry Mounting Box</p> <p>Magnetic Hookswitch (M)</p> <ul style="list-style-type: none"> • Completely sealed • No moving parts <p>32" Armored Cord Handset</p> <ul style="list-style-type: none"> • Optional cord lengths • Hearing aid compatible <p>4-Gang Mounting Box</p> <p>Tamper Resistant Security Screws</p> <p>SSP-351-D Model Automatic Dialer (D)</p> <ul style="list-style-type: none"> • Activated when the handset is lifted • Will auto dial a single number from 1-11 digits 	<p>Mini Stainless Steel Panel with Masonry Mounting Box</p> <p>Magnetic Hookswitch (M)</p> <ul style="list-style-type: none"> • Completely sealed • No moving parts <p>32" Armored Cord Handset</p> <ul style="list-style-type: none"> • Optional cord lengths <p>4-Gang Mounting Box</p> <p>Tamper Resistant Security Screws</p> <p>SSP-351-X Model Ring-down Operation (X)</p> <ul style="list-style-type: none"> • Activated when the handset is lifted • Can accept incoming calls • Can initiate a call when programmed to a customers PBX or phone system 	<p>Mini Stainless Steel Panel with Masonry Mounting Box</p> <p>Magnetic Hookswitch (M)</p> <p>32" Armored Cord Handset</p> <ul style="list-style-type: none"> • Optional cord lengths • Hearing aid compatible <p>4-Gang Mounting Box</p> <p>Tamper Resistant Security Screws</p> <p>IP-SSP-351-X Model</p> <p>(IP-) Analog unit that comes VoIP-ready with an externally powered ATA unit. (Requires AC Power)</p> <p>Ring-down Operation (X)</p> <ul style="list-style-type: none"> • Activated when the handset is lifted • Can accept incoming calls • Can initiate a call when programmed to a customers PBX or phone system

ADDITIONAL OPTIONS				
IP - Voice over Internet Protocol Version available on all models (SIP)				
-M	-LB	-ACH**	4 Gang Metal Masonry Box	301-064
				
<p>Sealed Magnetic Hookswitch</p> <ul style="list-style-type: none"> • Completely Sealed • No Moving Parts 	<p>32" handset with internal steel lanyard (braided metal rope) anchored into bracket installed on panel for added strength</p>	<p>Optional armored cord lengths from 12" to 72". Example: -ACH18 (18" armored cord handset).</p>	<p>4-gang metal masonry box flush mounting box Dimensions: 3.75"W x 7.40"H x 3.50" D</p>	<p>Security installation tool, required for installation</p>

Visit our website at www.ceeco.net or call us at 863-357-0798 for detail specifications on any of our models.