

PUBLIC PAYPHONE SIZE TELEPHONES

301/303 STAINLESS STEEL LARGE WALL HANDSET TELEPHONES

CEE CO's stainless steel series are high quality keypad telephones that are designed to withstand vandalism and areas subject to fraud and abuse. Their imposing design and impressive durability often helps to deter vandalism. The high grade stainless steel finish makes them aesthetically pleasing yet effortless to maintain, and their tamper resistant chrome plated instruction window makes it accommodating for customers to add specific instructions for their users. These rugged telephones are equipped with an industrial grade steel armored cord and swivel for added strength along with a hearing aid compatible handset. The backplate is compatible with existing type "1" coin and payphone enclosures for easy replacement. Their impressive size and durability are easy to locate for your toughest security, prison, emergency, and public communication needs. These reliable phones are built to last and supported by over 80 years of experience.



Features

Measurements:

7.5" W x 21" H x 6.5" D (W/ Handset on Hook)
 4.10"D (W/OUT Handset)

Stainless Steel Construction with Tamper Resistant Hardware

Chrome Plated Instruction Window with Area for Customer Specified Instructions

Marine Quality Chrome Tone Dial, Swivel, and Hearing Aid Compatible Handsets

Marine Quality Mechanical Hookswitch, or Optional Magnetic Hookswitch

Available in Standard, Smart (call restrictions and speed dial), Autodial and Ring-down Versions

Compatible Type "1" Payphone Mounting Backplate Included

1 Year Warranty

SPECIFICATIONS

- Weight:** Approximately 16 lbs.
- Mounting Instructions:** **Vertical Surface Mount:** Separate the cover assembly from the backplate. The backplate assembly is designed to be mounted on any flat vertical surface. Four mounting holes are provided.
- Environment:** Temperature: -30°C (-22°F) to 60°C (140°F)
 Humidity: 0%-90% non-condensing
- Input Power:** Telephone Line Powered
- Loop Current:** 23mA min to 80mA max
- Impedance:** 600 ohms
- Type Jack:** RJ11C
- Ringer Equivalency:** 0.4A
- Hearing Aid Compatible:** Meets EIA standards
- UL& FCC Registration:** Certified
- ACCESSORIES:** 301-037 Security Tool (required for installation)

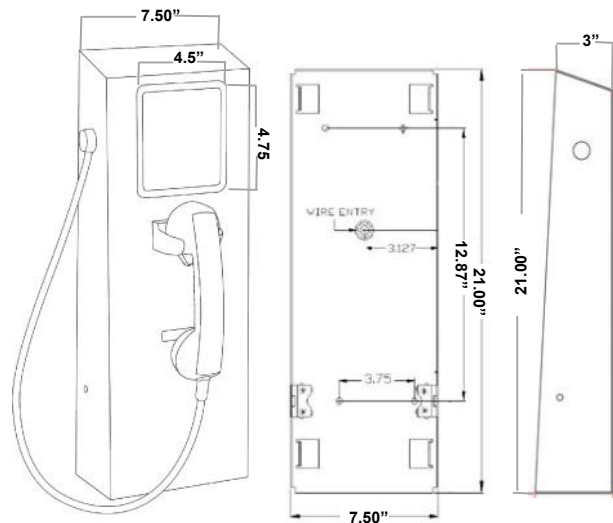











CEE CO has been providing telecom solutions since 1930. Our vandal resistant technology focuses on providing public communication solutions while reducing replacement and repair costs, lowering the customer's total cost of ownership. CEE CO also offers custom design and branding to your specifications. Our commitment to providing expert service and support extends beyond the warranty of our product. *We offer support for the life of the product!* CEE CO is devoted to giving you the quality and service you deserve.

PUBLIC PAYPHONE SIZE TELEPHONES

301/303 STAINLESS STEEL LARGE WALL TELEPHONES

All models are standard Analog, but also available in VoIP versions

PAYPHONE SIZE KEYPAD TELEPHONES	PAYPHONE SIZE AUTO DIAL TELEPHONES	PAYPHONE SIZE RING-DOWN TELEPHONES
		
Dimensions: 7 1/2" W x 21" H x 6 1/2" D	Dimensions: 7 1/2" W x 21" H x 6 1/2" D	Dimensions: 7 1/2" W x 21" H x 6 1/2" D
<p>Stainless Steel, Wall Mount Payphone Size Telephone</p> <p>Chrome Plated Instruction</p> <p>ID Window or Internal Volume Control Push Button</p> <p>Chrome Hookswitch and Cradle</p> <p>32" Armored cord handset</p> <ul style="list-style-type: none"> Hearing aid compatible Internal steel lanyard with swivel Optional cord length <p>Backplate for easy wall mounting or can be installed on to a existing payphone enclosure</p> <p>SSC-301-F Model Chrome Tone Dial Keypad (F)</p> <ul style="list-style-type: none"> Will allow incoming and outgoing calls <p>SSC-303-F Model Chrome Tone Dial Keypad (F) SMART Features</p> <ul style="list-style-type: none"> Allow or block incoming calls Call restriction capability Option to auto dial PBX or access numbers Programmable conversation time-out Optional speed dialing 	<p>Stainless Steel, Wall Mount Payphone Size Telephone</p> <p>Chrome Plated Instruction</p> <p>Chrome Hookswitch and Cradle</p> <p>32" Armored cord handset</p> <ul style="list-style-type: none"> Hearing aid compatible <p>Backplate for easy wall mounting or can be installed on to a existing payphone enclosure</p> <p>SSC-301-D Model Automatic Tone Dialer (D)</p> <ul style="list-style-type: none"> Activated when the handset is lifted Will allow incoming calls Will auto dial a single number from 1-11 digits <p>SSC-303-D Model Automatic Dialer (D) SMART Features</p> <ul style="list-style-type: none"> Can be programmed to dial up to 25 digits Optional access code prefix dialing No incoming calls allowed <p>SSC-303-DDD Model Three Separate Auto Dials (DDD)</p> <ul style="list-style-type: none"> Three programmable auto dial buttons that will auto dial a single number from 1-11 digits Ability to allow or block incoming calls 	<p>Stainless Steel, Wall Mount Payphone Size Telephone</p> <p>Chrome Plated Instruction</p> <p>ID Window or Internal Volume Control Push Button</p> <p>Chrome Hookswitch and Cradle</p> <p>32" Armored cord handset</p> <ul style="list-style-type: none"> Hearing aid compatible <p>Backplate for easy wall mounting or can be installed on to a existing payphone enclosure</p> <p>SSC-301-X Model Ring-down operation (X)</p> <ul style="list-style-type: none"> Activated when the handset is lifted Will allow incoming calls Initiate a call when programmed through a PBX or phone system

ADDITIONAL OPTIONS								IP - Voice over Internet Protocol Version available on all models (SIP)							
-M	-ACH**	-ACH*	-CCH*	-IVC	-BR	-RIL	-RIS								
															
Sealed Magnetic Hookswitch that uses standard handset. (no moving parts)	Other Length armored cord from 12" to 72"(inches). Example: -ACH12 12" Long	ACHW-White Handset ACHR-Red Handset (Black is standard)	Coiled cord available from 5', 10', & 15' (feet). Example: -CCH5 5' Long	ADA compliant push button volume control and background noise reducer (Built into phone)	Braille "EMERG. PHONE" emergency Plate	Ring Indicator Light located on the phone panel for visual ring indication	Ring Indicator Flashing Blue Light (Requires AC Power)								

Visit our website at www.ceeco.net or call us at 863-357-0798 for detail specifications on any of our models