

SSW-321-X TELEPHONE

Stainless Steel, Vandal Resistant, Rugged Telephones Built to Last

The SSW-321-X manual ringdown operation telephone is an easy to install unit designed for receiving and initiating calls through systems that recognize 'off-hook' conditions and route calls accordingly. The base model includes a 32" armored cord handset with an internal steel lanyard for added strength, mechanical or magnetic hookswitch assembly for durability, and a back plate for easy wall or surface mount installation. Volume control options can be added to improve sound quality and eliminate background noise for busy areas. The ease of installation and the immediate availability of replacement parts can significantly decrease the amount of work for maintenance personnel as well as lowering the cost of ownership. (*Security tool is required for installation*).



Made in the USA 

SPECIFICATIONS

INPUT POWER:	C.O. Line Powered or PBX
LOOP CURRENT:	23mA min to 80mA max *will work down to 15mA in most applications
IMPEDANCE:	600 ohms
SIGNALING:	DTMF
HEARING AID	
COMPATIBLE:	Meets EIA standards
ENVIRONMENTAL:	Temperature: -30°C (-22°F) to 60°C (140°F) Humidity 0%-90% non-condensating
RINGER EQUIVALENCY:	0.4A
TYPE JACK:	RJ11C
TELEPHONE COVER:	Brushed 16 ga. Stainless Steel
DIMENSIONS:	5" Wide x 10 3/4" High x 5.5" Deep (handset on-hook)
MOUNTING:	Vertical surface mount
WEIGHT:	7 lbs.
FCC REGISTRATION:	BW-88T7-13717-TE-T
UL LISTED NO.:	6OF5

ACCESSORIES:

301-037	Security Tool (required for installation)
---------	--



FEATURES

Measurements: 5"W x 10 3/4"H x 5 1/2"D

Stainless Steel Construction with Tamper Resistant Hardware

Marine Quality Chrome Mechanical or Magnetic Hookswitch

Hearing Aide Compatible Armored Cord Handset with Internal Steel Lanyard

Mounting Backplate Included

Optional pushbutton volume control with background noise reduction on panel.

Analog line powered, VoIP model available

Customization Available, call to discuss requirements

Replacement & Repair Parts Available for Purchase

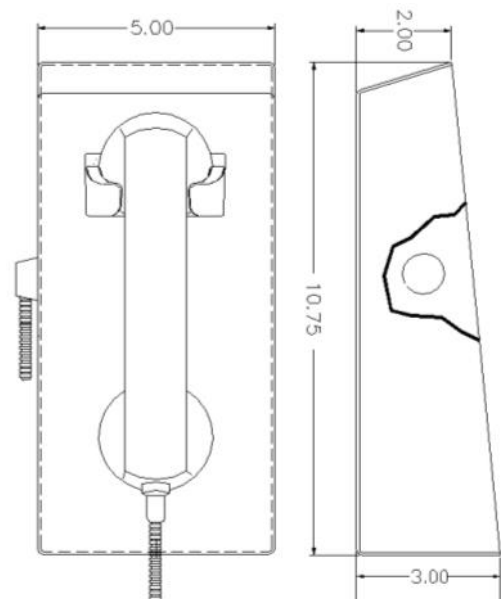

Providing Telecommunication Solutions Since 1930

Communication Equipment
& Engineering Company

Web: www.ceeco.net

Email: sales@ceeco.net



519 SW Park Street
Okeechobee, FL 34972

Voice 863-357-0798









Fax 863-357-0006

SSW-321-X TELEPHONE

PRODUCT MANUALS WITH FULL FEATURES AND FUNCTIONS AVAILABLE UPON REQUEST

				
SSW-321-X-ACHW	SSW-321-X-M-IVC-ACHR	SSW-321-X-M-ACH12	SSW-321-X-RIL-BR	SSW-321-D-X-IVC-RIS
Our sturdy, attractive and durable SSW-321-X-ACHW is designed for special applications where the user cannot initiate a call; however, the unit accepts incoming calls. External automatic dialing equipment can be used, allowing it to automatically dial a number when handset is lifted.	The SSW-321-X-M-IVC-ACHR model is equipped with a sealed magnetic hookswitch (M) and internal volume control with background noise reduction button on the face of the housing (IVC). The Red handset (ACHR) visually indicates that this is an emergency phone.	The SSW-321-X-M-ACH12 model with the magnetic hookswitch (M) and 12" armored cord handset (ACH12) is widely used in mental institutes or places where the need for minimal moveable parts and shorter cords are necessary to reduce abuse to the unit and the user.	The SSW-321-X-RIL-BR model with a Ring Indicator Light (RIL) and Braille EMER emergency Plate (BR) offers dependable communication for locations requiring a direct hot line phone such as emergency response, direct connect, customer service, entry approval, and security stations.	The SSW-321-X-M-IVC-RIS model with the magnetic hookswitch (M), internal volume control (IVC) and ring indicator strobe light (RIS) is commonly used in warehouses, college campus or noisy areas where it is necessary to visually see the phone ringing from afar.
Dimensions: 5"W x 10 3/4"H x 5 1/2"D Weight: 7lbs Product Link: Click here	Dimensions: 5"W x 10 3/4"H x 5 1/2"D Weight: 7lbs Product Link: Click here	Dimensions: 5"W x 10 3/4"H x 5 1/2"D Weight: 7lbs Product Link: Click here	Dimensions: 5"W x 10 3/4"H x 5 1/2"D Weight: 7lbs Product Link: Click here	Dimensions: 5"W x 12"H x 5 1/2"D Weight: 8lbs Product Link: Click here

ADDITIONAL OPTIONS

-M	-IVC	-ACH**	-ACH*	-CCH*	-BR	-RIL	-RIS	IP-
								
Sealed Magnetic Hookswitch that uses standard handset. (no moving parts)	ADA compliant push button volume control and background noise reducer. (Built into phone)	Other Length armored cord from 12" to 72"(inches). Example: -ACH12 12" Long	ACHW -White Handset ACHR -Red Handset (Black is standard)	Coiled cord available from 5', 10', & 15' (feet). Example: -CCH5 5' Long	Braille "EMER PHONE" emergency Plate	Ring Indicator Light located on the phone panel for visual ring indication.	Ring Indicator Flashing Blue Light continuously lit and flashes during call duration (Requires AC Power)	IP-SSW-321-X available for SIP Protocol VoIP (Requires AC Power)

IP - Voice over Internet Protocol Version available on all models (SIP) **CUSTOMIZATION** - Call us for MORE additional options and features

Visit our website at www.ceeco.net or call us at 863-357-0798 for detail specifications on any of our models.

CEECO has been providing telecom solutions since 1930. Our vandal resistant technology focuses on providing public communication solutions while reducing replacement and repair costs, lowering the customer's total cost of ownership. CEECO also offers custom design and branding to your specifications. Our commitment to providing expert service and support extends beyond the warranty of our product. We offer support for the life of the product! CEECO is devoted to giving you the quality and service you deserve.



Providing Telecommunication Solutions Since 1930

Communication Equipment & Engineering Company	519 SW Park Street Okeechobee, FL 34972
Web: www.ceeco.net	Voice 863-357-0798
Email: sales@ceeco.net	Fax 863-357-0006